



FDV SPEC SHEET

Ledline

Art. no: 805005-3-ddd



Lighting Solutions

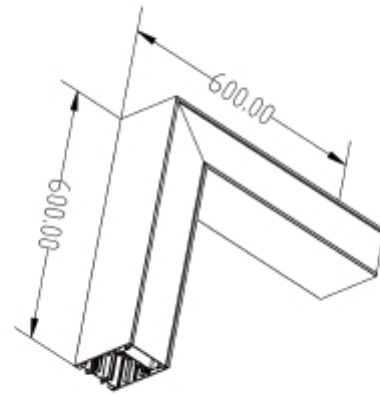
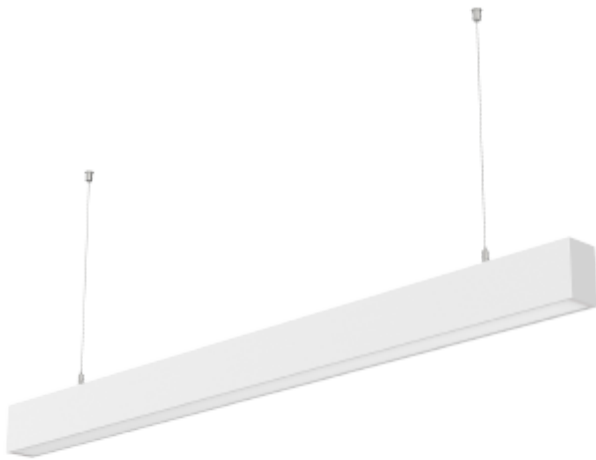

Ledline

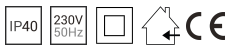

Art. no: 805005-3-ddd

LIGHT TECHNICAL

Lightsource Type:	LED (built in)
Lumen Output:	3650
Lumen LED (tc=25):	4400
Beam Angle:	110
CCT (Color Temperature):	3000
CRI / Ra:	80
Color Code:	830
Lens (Diffuser):	Opal

MOUNTING / CONNECTION

Connection:	LEDLine 5-pin
Mounting:	Recessed, Surface, Ceiling, Pendan

ELECTRICAL DATA

Dimming:	DALI
System Power [W]:	40
System Voltage [V]:	230V 50Hz
Protection Class:	2
Max load pr circuit - B10:	16
Max load pr circuit - B16:	25
Max load pr circuit - C10:	18
Max load pr circuit - C16:	28
Leakage current [mA]:	0,25
Inrush current I _{max} [A]:	60
Inrush current time [μs]:	3,5
Socket / Cap-Base:	N/A
Current Output [mA]:	450
Voltage Forward Min [V]:	32
Voltage Forward Max [V]:	48



FDV SPEC SHEET

Ledline

Art. no: 805005-3-ddd



Lighting Solutions

PRODUCT

Ingress Protection:	IP40
Impact Protection:	IK08
Lifetime [h]:	L80B10: 100 000
Color:	White
Length [mm]:	600
Height [mm]:	84
Width [mm]:	600
Weight [kg]:	3,3