



## FDV SPEC SHEET

Zoom Spotlight

Art. no: 101142-660-3-p



Lighting Solutions

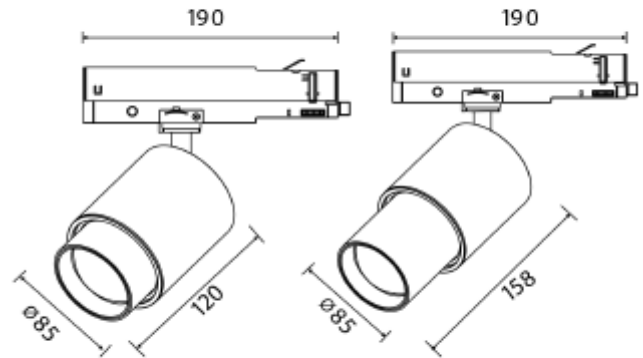

# Zoom Spotlight



Art. no: 101142-660-3-p

### LIGHT TECHNICAL

Lightsource Type:	LED (built in)
Lumen LED (tc=25):	1850
Beam Angle:	6-60
CCT (Color Temperature):	3000
CRI / Ra:	90
Color Code:	930
MacAdam (SDCM):	3
Lens (Diffuser):	Clear

### MOUNTING / CONNECTION

Connection:	Track 3-Circuit
Mounting:	Track

### ELECTRICAL DATA

Dimming:	Phase-Cut
Flickerfree:	Yes
Flicker metric (Pst LM) <:	1
Stroboscopic effect metric (SVM) <:	0,4
System Power [W]:	20
System Voltage [V]:	230V 50Hz
Dimming Output Type:	Amplitude Modulation
Dimming Phasecut Type:	Trailing edge
Protection Class:	1
Max load pr circuit - B10:	28
Max load pr circuit - B16:	46
Max load pr circuit - C10:	28
Max load pr circuit - C16:	46
Inrush current I <sub>max</sub> [A]:	15
Inrush current time [µs]:	40
Socket / Cap-Base:	N/A
Current Output [mA]:	500
Voltage Forward Min [V]:	35
Voltage Forward Max [V]:	40



## FDV SPEC SHEET

Zoom Spotlight

Art. no: 101142-660-3-p



*Lighting Solutions*

### PRODUCT

Ingress Protection:	IP20
Lifetime [h]:	L80B10: 100 000
Color:	White
RAL:	RAL9003
Length [mm]:	158
Diameter [mm]:	85
Weight [kg]:	1
Housing Material :	Aluminium