



FDV SPEC SHEET

Cone Spotlight

Art. no: 101203-40-3



Lighting Solutions

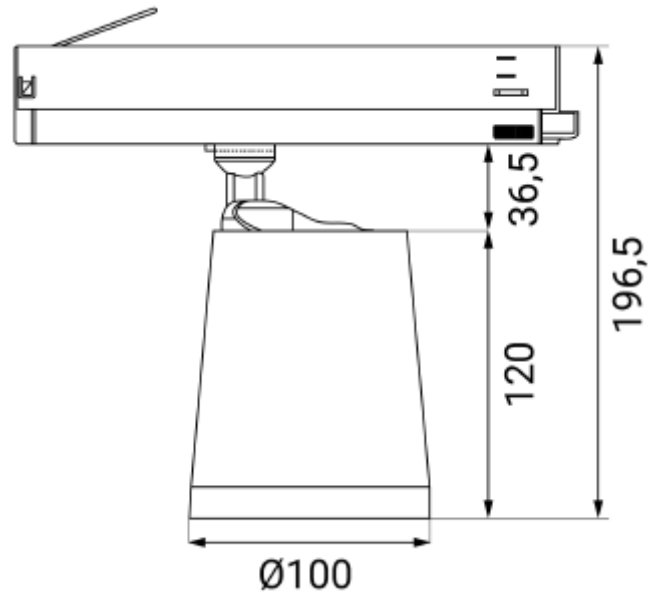

Cone Spotlight



Art. no: 101203-40-3

LIGHT TECHNICAL

Lightsource Type:	LED (built in)
Lumen Output:	2260
Lumen LED (tc=25):	3200
Beam Angle:	40
CCT (Color Temperature):	3000
CRI / Ra:	90
Color Code:	930
MacAdam (SDCM):	3
Lens (Diffuser):	Clear

MOUNTING / CONNECTION

Connection:	Track 3-Circuit
Mounting:	Track, Ceiling

PRODUCT

Ingress Protection:	IP20
Operating Temperature [°C]:	0 - 35
Lifetime [h]:	L80B10: 100 000
Color:	White
Height [mm]:	196,5
Width [mm]:	100
Weight [kg]:	0,75

ELECTRICAL DATA

Dimming:	None
System Power [W]:	26
System Voltage [V]:	230V 50Hz
Protection Class:	1
Max load pr circuit - B10:	15
Max load pr circuit - B16:	25
Max load pr circuit - C10:	25
Max load pr circuit - C16:	43
Inrush current I _{max} [A]:	42
Inrush current time [µs]:	160
Socket / Cap-Base:	N/A
Current Output [mA]:	700