



FDV SPEC SHEET

Trimo Mini

Art. no: 18020-7-40-2-ddd



Lighting Solutions

 112mm

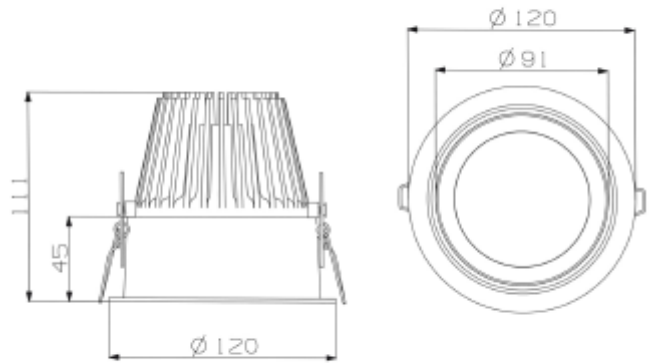

Trimo Mini



Art. no: 18020-7-40-2-ddd

LIGHT TECHNICAL

Lightsource Type:	LED (built in)
Lumen Output:	2890
Lumen LED (tc=25):	3650
Beam Angle:	40°
CCT (Color Temperature):	3000
CRI / Ra:	80
Color Code:	830
MacAdam (SDCM):	3
Lens (Diffuser):	Clear

MOUNTING / CONNECTION

Connection:	18i5 DALI Quick connection
Cut-out [mm]:	Ø112
Mounting:	Recessed, Ceiling

ELECTRICAL DATA

Dimming:	DALI
Dimming Output Type:	Amplitude Modulation
System Power [W]:	24
System Voltage [V]:	230V 50Hz
Protection Class:	2
Max load pr circuit - B10:	19
Max load pr circuit - B16:	32
Max load pr circuit - C10:	31
Max load pr circuit - C16:	53
Leakage current [mA]:	0,15
Inrush current I _{max} [A]:	26
Inrush current time [µs]:	151
Socket / Cap-Base:	N/A
Current Output [mA]:	600
Voltage Forward Min [V]:	30,2
Voltage Forward Max [V]:	41,7



FDV SPEC SHEET

Trimo Mini

Art. no: 18020-7-40-2-ddd



Lighting Solutions

PRODUCT

To be recessed in insulation:	No
Ingress Protection:	IP20
Lifetime [h]:	L80B10: 100 000
Color:	Black
Height [mm]:	110
Width [mm]:	122
Weight [kg]:	0,7