



PRODUCT SHEET

Polaris

Art. no: 3001-60-3



Lighting Solutions

Polaris

 200-210mm

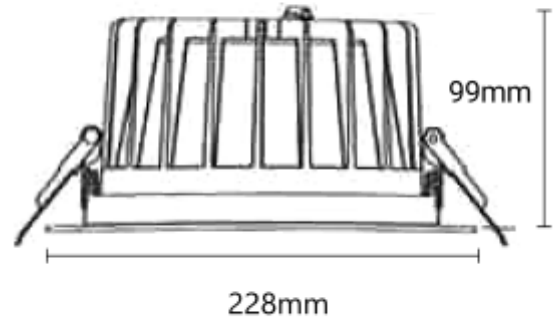

SPECIFICATIONS

Lightsource Type:	LED (built in)
System Power [W]:	25W
CCT (Color Temperature):	3000K
CRI / Ra:	80
Lumen Output:	3074lm
Lumen LED (tc=25):	3300lm
Beam Angle:	60°
Lens (Diffuser):	Clear
Dimming:	Depending on Driver
System Voltage [V]:	230V 50Hz
Connection:	Depending on driver
Mounting:	Recessed, Ceiling
Cut-out [mm]:	Ø200-Ø210mm
Lifetime [h]:	L80B10: 100 000h
MacAdam (SDCM):	3
Color:	White
Length [mm]:	228mm
Height [mm]:	99mm
Width [mm]:	228mm
Weight [kg]:	1,14kg
To be recessed in insulation:	Not applicable

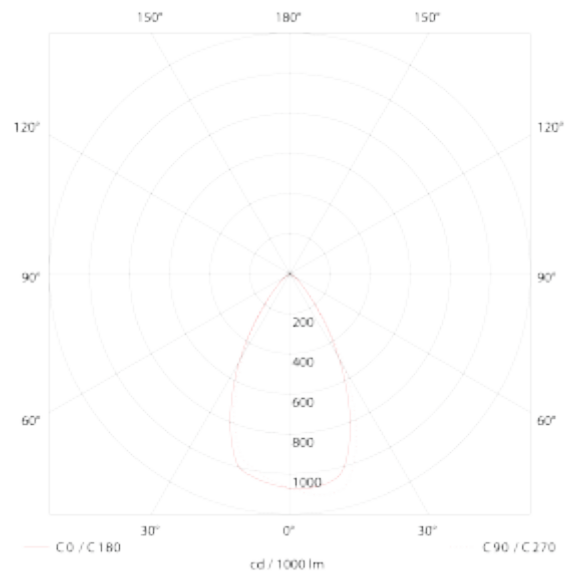

This luminaire has quickly become a very popular downlight for general lighting. The Polaris is designed with a precise reflector, ensuring a high lumen value without glare. Polaris is delivered without driver. See accessories for correct driver.