



FDV SPEC SHEET

Exilis II dim

Art. no: 2605-01-3



Lighting Solutions

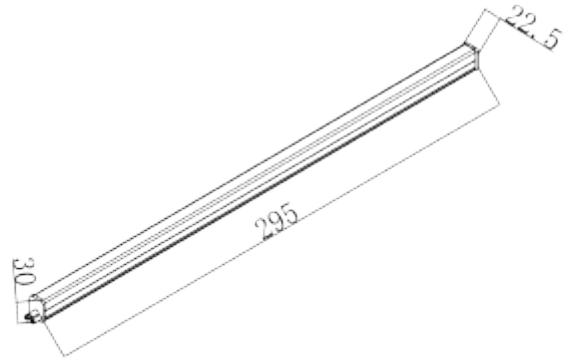

Exilis II dim



Art. no: 2605-01-3



FDV SPEC SHEET

Exilis II dim

Art. no: 2605-01-3



LIGHT TECHNICAL	
Lumen LED (tc=25):	550
Beam Angle:	120°
CCT (Color Temperature):	4000
CRI / Ra:	80
Color Code:	840
Lens (Diffuser):	Opal
Dimming:	Phase-Cut
Dimming Phasecut Type:	Leading edge
System Power [W]:	5
System Voltage [V]:	230V 50Hz
Protection Class:	1
Max load pr circuit - B10:	32
Max load pr circuit - B16:	52
Max load pr circuit - C10:	32
Max load pr circuit - C16:	52
Leakage current [mA]:	0,5
Inrush current I _{max} [A]:	0,31
Socket / Cap-Base:	N/A
Connection:	Exilis II 3-pin Connector
Ingress Protection:	IP20
Operating Temperature [°C]:	-20 - 40
Lifetime [h]:	L80B10: 100 000
Color:	Aluminium
Length [mm]:	295
Height [mm]:	30
Width [mm]:	22