



PRODUCT SHEET

Exilis II dim

Art. no: 2605-01-3



Lighting Solutions

Exilis II dim

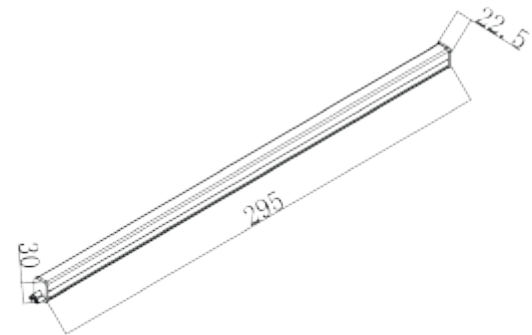

Our LED tube luminaire with a built in LED driver makes installation a breeze. The Exilis II comes in a variety of lengths that can be easily be connected together without the use of tools, just by clicking the LED tubes together. The different lengths makes it very easy to make a continuous line of light regardless of the length of the surface. The Exilis II comes with a opal diffuser and phasecut dim. Max 500W for each feed.



SPECIFICATIONS

System Power [W]:	5W
CCT (Color Temperature):	4000K
CRI / Ra:	80
Lumen LED (tc=25):	550lm
Beam Angle:	120°
Lens (Diffuser):	Opal
Dimming:	Phase-Cut
System Voltage [V]:	230V 50Hz
Connection:	Exilis II 3-pin Connector
Lifetime [h]:	L80B10: 100 000h
Lumen/W:	110lm/W
Color:	Aluminium
Length [mm]:	295mm
Height [mm]:	30mm
Width [mm]:	22mm