



FDV SPEC SHEET

X-Clean

Art. no: 6802-02-1



Lighting Solutions

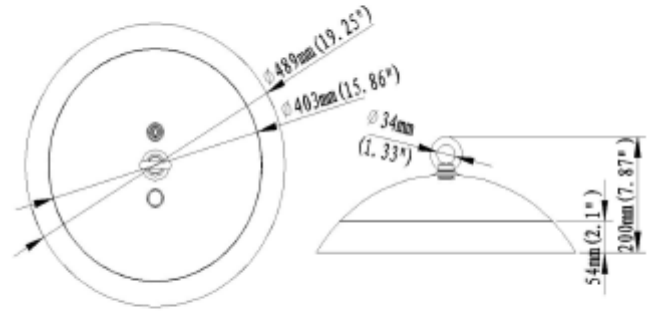

X-Clean



Art. no: 6802-02-1

LIGHT TECHNICAL

Lightsource Type:	LED (built in)
Lumen Output:	12700
Lumen LED (tc=25):	16800
Beam Angle:	90°
CCT (Color Temperature):	4000
CRI / Ra:	80
Color Code:	840

PRODUCT

Ingress Protection:	IP69
Impact Protection:	IK10
Operating Temperature [°C]:	-30 - 50
Lifetime [h]:	L80B50: 100 000
Color:	Grey
Height [mm]:	200
Width [mm]:	489
Weight [kg]:	7,3
Housing Material :	Aluminium

ELECTRICAL DATA

Dimming:	None
Dimming Output Type:	Amplitude Modulation
Standby power P _{sb} (W) <:	0,5
Flicker metric (P _{st} LM) <:	0,007
Stroboscopic effect metric (SVM) <:	0,019
System Power [W]:	120
System Voltage [V]:	230V 50Hz
Protection Class:	1
Max load pr circuit - B10:	3
Max load pr circuit - B16:	5
Max load pr circuit - C10:	5
Max load pr circuit - C16:	9
Leakage current [mA]:	0,75
Inrush current I _{max} [A]:	60
Inrush current time [µs]:	375
Socket / Cap-Base:	N/A

MOUNTING / CONNECTION

Connection:	Cable 1.5m
Mounting:	Suspended, Ceiling, Surface