

**FDV DOCUMENTATION**

Zeta Mini 3350lm 930 30° 28W GR 18i3

Art.no: 1008-30-1

*Lighting Solutions*

155mm

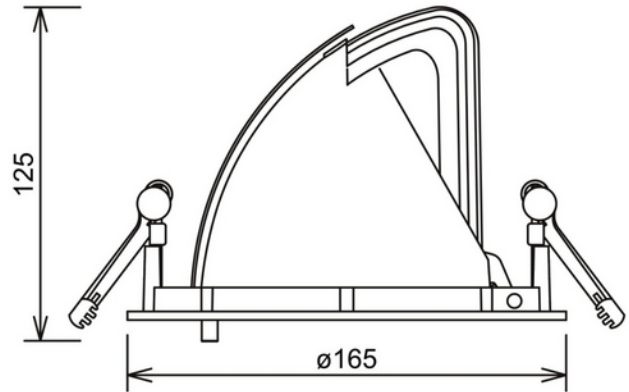

Zeta Mini 3350lm 930 30° 28W GR 18i3



SPECIFICATIONS	
Forward Voltage LED (max tp=25) (V)	41.7
Forward Voltage LED (min tp=65) (V)	30.2
CC (forward voltage driver) (V)	44.0
Inrush current time (µs)	150.0
Inrush current I _{max} (A)	25.0
Length (product) (mm)	165.0
Width (product) (mm)	165.0
Height (product) (mm)	125.0
Weight (product) (kg)	0.95



FDV DOCUMENTATION

Zeta Mini 3350lm 930 30° 28W GR 18i3

Art.no: 1008-30-1



Lighting Solutions

LIGHT DISTRIBUTION

