

**PRODUCT DATA SHEET**

Zeta Mini 3950lm 830 30° 28W GR 18i3

Art.no: 1018-30-1

*Lighting Solutions*

155mm

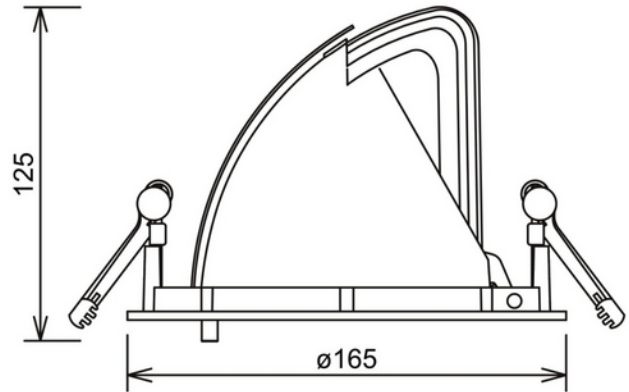

## Zeta Mini 3950lm 830 30° 28W GR 18i3



Zeta Mini is a small flexible LED downlight replacing the well-known Zebra mini, offering the same great quality and adjustment possibilities. The Zeta mini is supplied with 18i3 cable connector and can be delivered with a variety of connection options. The down light is available in three different colors.

ELECTRICAL DATA	
Protection Class (system)	2
Dimming (system)	None
Voltage (system) [V]	230V 50Hz

TECHNICAL DATA	
IP (system)	IP20
Outdoor	No

PHOTOMETRIC DATA	
CRI / Ra (>=)	80

**PRODUCT DATA SHEET**

Zeta Mini 3950lm 830 30° 28W GR 18i3

Art.no: 1018-30-1

*Lighting Solutions*

PHOTOMETRIC DATA	
CCT (Color Temperature) (K)	3000
Color Code	830
Lightsource Type	LED (built in)
Lens (Diffuser)	Clear
Lifetime (h)	L80B10: 100 000
MacAdam (SDCM)	3
Manufacturer (light source)	Tridonic
Forward Current LED (min-max) (mA)	150 - 900
Forward Voltage LED (max tp=25) (V)	36.3
Driftspenning LED (min tp=65) (V)	31.7

DRIVER	
Manufacturer (driver)	Tridonic
Protection Class (driver)	1 or 2
Max Output Voltage (V)	60
IP (driver)	IP20
Expected Lifetime (driver) (h)	50000
Constant current or voltage (CC or CV)	CC
CC (driver) [mA]	700 - null
CC (forward voltage driver) (V)	21.4 - 44.0
Output Current Tolerance (%)	7.5
Current Ripple (%)	5.0
Max load pr circuit - B10	14
Max load pr circuit - B16	24
Max load pr circuit - C10	24
Max load pr circuit - C16	40
Inrush current time ( $\mu$ s)	150.0
Inrush current I <sub>max</sub> (A)	25.0

DIMENSIONS	
Length (product) (mm)	165.0
Width (product) (mm)	165.0
Height (product) (mm)	125.0
Weight (product) (kg)	0.95

**PRODUCT DATA SHEET**

Zeta Mini 3950lm 830 30° 28W GR 18i3

Art.no: 1018-30-1

*Lighting Solutions*

MATERIALS AND SURFACES	
Color	Grey

INSTALLATION AND CONNECTION	
Areas of use	Office, Shop, Showroom
Mounting	Recessed, Ceiling
Connection (system)	18i3 Quick connection

ENERGY AND CERTIFICATIONS	
CE mark	Yes
Energy Efficiency Class	A++ - A

ALTERNATIVE DRIVERS	
Current Setting (mA) ?	700

**LIGHT DISTRIBUTION**