

**PRODUCT DATA SHEET**

Zeta Mini 4200lm 830 30° 27W WH 18i3-plug Ø155mm

Art.no: 1018-8-30-3

*Lighting Solutions*

155mm

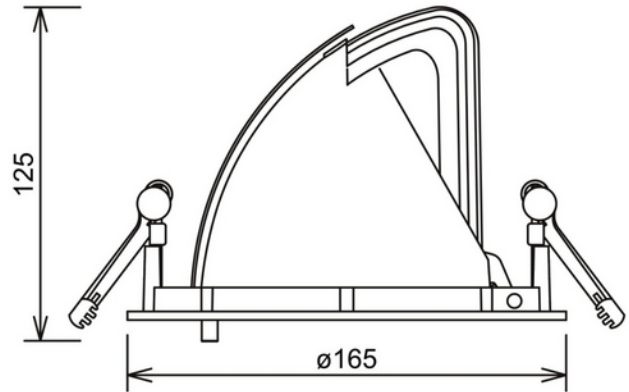

Zeta Mini 4200lm 830 30° 27W WH 18i3-plug Ø155mm



Zeta Mini is a small flexible LED downlight replacing the well-known Zebra mini, offering the same great quality and adjustment possibilities. The Zeta mini is supplied with 18i3 cable connector and can be delivered with a variety of connection options. The down light is available in three different colors.

ELECTRICAL DATA	
Protection Class (system)	2
Dimming (system)	None
Voltage (system) [V]	230V 50Hz

TECHNICAL DATA	
IP (system)	IP20
Outdoor	No

PHOTOMETRIC DATA	
CRI / Ra (>=)	80

**PRODUCT DATA SHEET**

Zeta Mini 4200lm 830 30° 27W WH 18i3-plug Ø155mm

Art.no: 1018-8-30-3

*Lighting Solutions*

PHOTOMETRIC DATA	
CCT (Color Temperature) (K)	3000
Color Code	830
Lightsource Type	LED (built in)
Lens (Diffuser)	Clear
Lifetime (h)	L80B10: 100 000
Manufacturer (light source)	Tridonic

DRIVER	
Manufacturer (driver)	Tridonic
Protection Class (driver)	1 or 2
Max Output Voltage (V)	60
IP (driver)	IP20
Expected Lifetime (driver) (h)	50000
Constant current or voltage (CC or CV)	CC
CC (driver) [mA]	700 - null
CC (forward voltage driver) (V)	21.4 - 44.0
Output Current Tolerance (%)	7.5
Current Ripple (%)	5.0
Max load pr circuit - B10	14
Max load pr circuit - B16	24
Max load pr circuit - C10	24
Max load pr circuit - C16	40
Inrush current time (µs)	150.0
Inrush current I _{max} (A)	25.0

DIMENSIONS	
Length (product) (mm)	165.0
Width (product) (mm)	165.0
Height (product) (mm)	125.0
Weight (product) (kg)	0.95

MATERIALS AND SURFACES	
Color	White

**PRODUCT DATA SHEET**

Zeta Mini 4200lm 830 30° 27W WH 18i3-plug Ø155mm

Art.no: 1018-8-30-3

*Lighting Solutions*

INSTALLATION AND CONNECTION	
Areas of use	Office, Shop, Showroom
Mounting	Recessed, Ceiling
Connection (system)	18i3 Quick connection

ENERGY AND CERTIFICATIONS	
CE mark	Yes
Energy Efficiency Class	A++ - A

ALTERNATIVE DRIVERS	
Current Setting (mA) ?	700