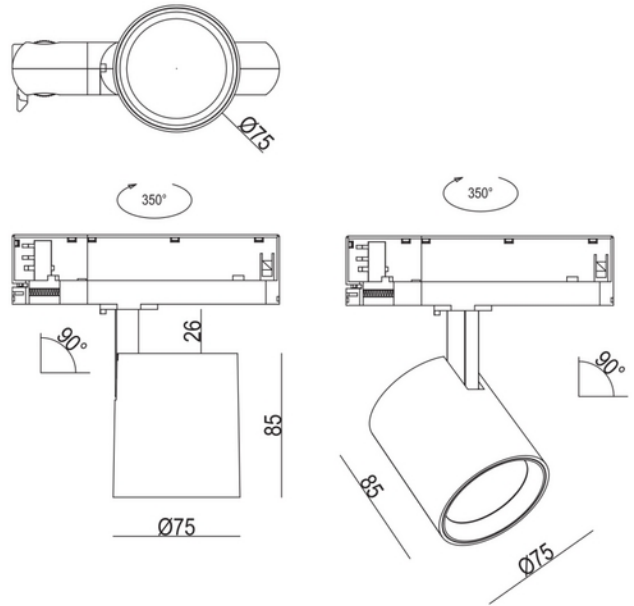

**FDV DOCUMENTATION**

Rod Mini C 1800lm 930 36° 15W GR 3-circuit

Art.no: 102531-36-1

*Lighting Solutions*

Rod Mini C 1800lm 930 36° 15W GR 3-circuit



SPECIFICATIONS	
Operating temperature (°C)	45
Forward Voltage LED (max tp=25) (V)	38.0
Forward Voltage LED (min tp=65) (V)	33.0
CC (driver) [mA]	1050
CC (forward voltage driver) (V)	42.0
Inrush current time (µs)	70.0
Inrush current I _{max} (A)	2.025
Height (product) (mm)	85.0
Weight (product) (kg)	0.5333333333333333
Diameter (product) (mm)	75.0