

**FDV DOCUMENTATION**

Milli Maxi 2100lm 18W 930 50° BK IP44 Ø150mm w/o driver
 Art.no: 102741-50-2

*Lighting Solutions*

Milli Maxi 2100lm 18W 930 50° BK IP44 Ø150mm w/o driver

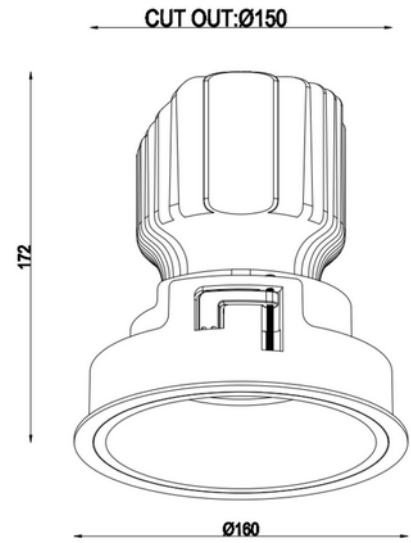

SPECIFICATIONS	
Operating temperature (°C)	45
Forward Voltage LED (max tp=25) (V)	38.0
Forward Voltage LED (min tp=65) (V)	33.0
Width (product) (mm)	164.0
Height (product) (mm)	172.0
Weight (product) (kg)	1.5625
Diameter (product) (mm)	160.0
Mounting	Recessed, Ceiling