



PRODUCT DATA SHEET

Milli Maxi 2100lm 18W 930 50° BK IP44 Ø150mm w/o driver
Art.no: 102741-50-2



Lighting Solutions

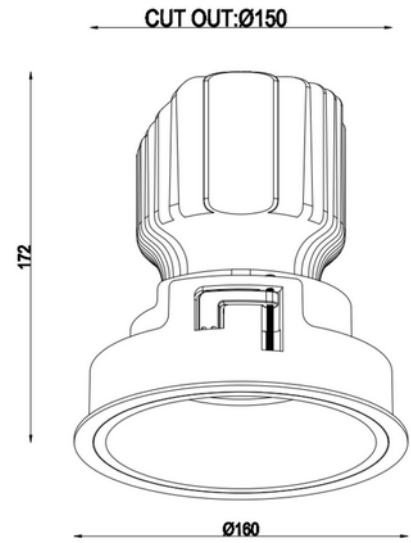

Milli Maxi 2100lm 18W 930 50° BK IP44 Ø150mm w/o driver



ELECTRICAL DATA	
Protection Class (system)	3
Dimming (system)	Depending on Driver
Voltage (system) [V]	230V 50Hz
Emergency light (h)	No Emergency light

TECHNICAL DATA	
IK (system)	IK02
IP (system)	IP44
IP Front/Back (system)	IP44/20
Outdoor	No
Operating temperature (°C)	-20 - 45

**PRODUCT DATA SHEET**

Milli Maxi 2100lm 18W 930 50° BK IP44 Ø150mm w/o driver

Art.no: 102741-50-2

*Lighting Solutions*

PHOTOMETRIC DATA	
Efficacy (system) (lm/W)	116
CRI / Ra (>=)	90
CCT (Color Temperature) (K)	3000
Color Code	930
Lightsource Type	LED (built in)
Socket / Cap-Base	N/A
Lens (Diffuser)	Lens
Lifetime (h)	L80: 100 000
MacAdam (SDCM)	3
UGR (<=)	19
Manufacturer (light source)	Bridgelux
Forward Current LED (min-max) (mA)	150 - 720
Forward Voltage LED (max tp=25) (V)	38.0
Driftspenning LED (min tp=65) (V)	33.0

DRIVER	
Manufacturer (driver)	No driver

DIMENSIONS	
Width (product) (mm)	164.0
Height (product) (mm)	172.0
Weight (product) (kg)	1.5625
Diameter (product) (mm)	160.0

MATERIALS AND SURFACES	
Color	Black
RAL Code	RAL9005
Corrosion Class	C1
Surface treatment	Powdercoated
Housing Material	Aluminium
Housing Material %	87.11
Diffuser Material	Aluminium
Diffuser Material%	3.04
Recycled Plastic %	3.73
Recycled Aluminium %	88.03

**PRODUCT DATA SHEET**

Milli Maxi 2100lm 18W 930 50° BK IP44 Ø150mm w/o driver

Art.no: 102741-50-2

*Lighting Solutions*

MATERIALS AND SURFACES	
Material 2%	1.38
Material 3%	0.9299999999999999
Material 4%	1.6099999999999999
Material 5%	0.38
Material 6%	0.54
Material 7%	0.38
Material 8%	2.9000000000000004
Material 9%	0.83

INSTALLATION AND CONNECTION	
Areas of use	Hotel, Shop
Mounting	Recessed, Ceiling
Connection (system)	18i3 Quick connection

ENERGY AND CERTIFICATIONS	
Energy Class EPREL	F
CE mark	Yes