

**FDV DOCUMENTATION**

Cold 5 Surface 1150lm 927 30° 5x2W BK Phasecut
Art.no: 1121-30-2

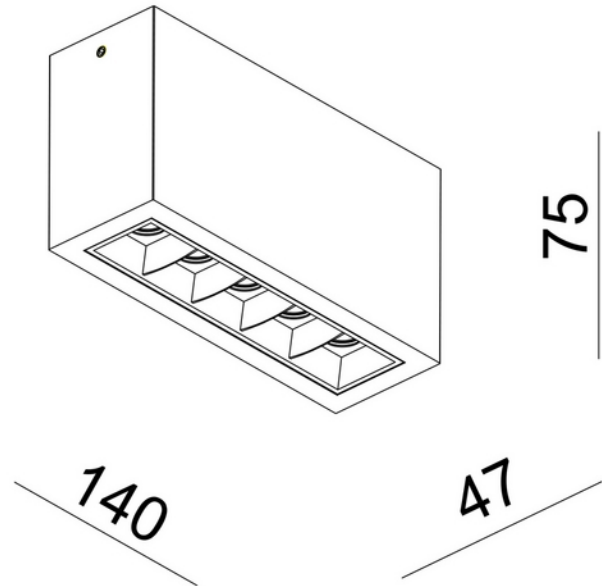

Lighting Solutions



Cold 5 Surface 1150lm 927 30° 5x2W BK Phasecut



SPECIFICATIONS	
Forward Voltage LED (max tp=25) (V)	15.0
Length (product) (mm)	140.0
Width (product) (mm)	47.0
Height (product) (mm)	75.0