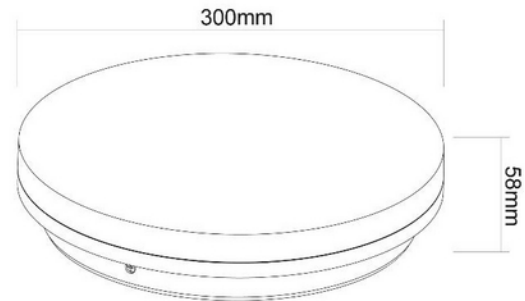

**PRODUCT DATA SHEET**

Pollux 1750lm 830/840/857 Switch 120° 18W WH IP54

Art.no: 2112-120-3

*Lighting Solutions*

## Pollux 1750lm 830/840/857 Switch 120° 18W WH IP54



Pollux is a surface mounted ceiling light that adopts high lumen SMD LED, fire-rated PC diffuser with even light output. IP54 waterproof structural design, it s an ideal replacement for wet locations. Comes with a switch option between 3000K (default), 4000K and 5700K. QuickConnect for easy installation. All data is based on 4000K.

ELECTRICAL DATA	
Protection Class (system)	2
Dimming (system)	None
Voltage (system) [V]	230V 50Hz

TECHNICAL DATA	
IK (system)	IK10
IP (system)	IP54
Outdoor	No

**PRODUCT DATA SHEET**

Pollux 1750lm 830/840/857 Switch 120° 18W WH IP54

Art.no: 2112-120-3

*Lighting Solutions*

PHOTOMETRIC DATA	
Efficacy (system) (lm/W)	91
CRI / Ra (>=)	80
CCT (Color Temperature) (K)	3/4/5700
Color Code	830/840/857
Lightsource Type	LED (built in)
Socket / Cap-Base	N/A
Lens (Diffuser)	Opal
Lifetime (h)	L80B10: 100 000
MacAdam (SDCM)	3
Manufacturer (light source)	Everlight

DRIVER	
Manufacturer (driver)	Up-Shine
Protection Class (driver)	2
Standby power P <sub>sb</sub> (W) <	0.5
Flicker metric (P <sub>st</sub> LM) <	1.0
Stroboscopic effect metric (SVM) <	0.4
Max Output Voltage (V)	80
IP (driver)	IP20
Expected Lifetime (driver) (h)	50000
Flicker-free	Yes
Constant current or voltage (CC or CV)	CC
CC (driver) [mA]	230 - null
CC (forward voltage driver) (V)	60.0 - 80.0
Output Current Tolerance (%)	5.0
Current Ripple (%)	5.0
Max load pr circuit - B10	37
Max load pr circuit - B16	59
Max load pr circuit - C10	37
Max load pr circuit - C16	59
Leakage current (mA)	0.75
Inrush current time (µs)	12.0
Inrush current I <sub>max</sub> (A)	19.6



## PRODUCT DATA SHEET

Pollux 1750lm 830/840/857 Switch 120° 18W WH IP54

Art.no: 2112-120-3



*Lighting Solutions*

DIMENSIONS	
Width (product) (mm)	300.0
Height (product) (mm)	58.0
Weight (product) (kg)	1.05

MATERIALS AND SURFACES	
Color	White
Housing Material	Polycarbonate
Diffuser Material	Polycarbonate

INSTALLATION AND CONNECTION	
Areas of use	Cottage, Generally, Hotel, Office, Residence
Mounting	Surface, Ceiling
Connection (system)	QuickConnect

ENERGY AND CERTIFICATIONS	
Energy Class EPREL	F
CE mark	Yes
Energy Efficiency Class	A++ - A

## LIGHT DISTRIBUTION

