

**FDV DOCUMENTATION**

Ceto Fixed 1100lm 15W 930 36° BK EPN Phasecut cutout 92mm

Art.no: 28930-2-36-2

*Lighting Solutions*

92mm

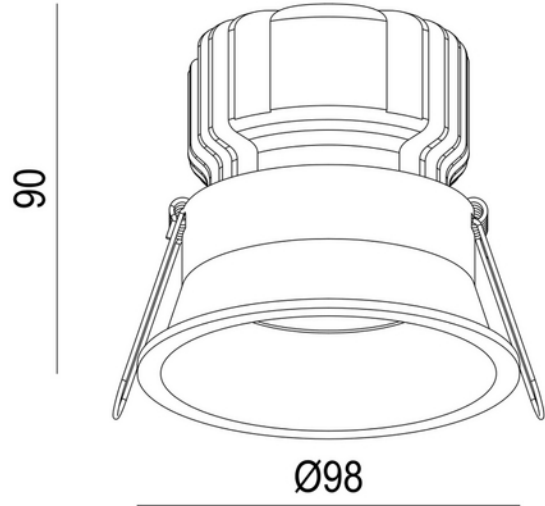

Ceto Fixed 1100lm 15W 930 36° BK EPN Phasecut cutout 92mm



SPECIFICATIONS	
Operating temperature (°C)	45
Forward Voltage LED (max tp=25) (V)	36.0
Forward Voltage LED (min tp=65) (V)	32.0
CC (driver) [mA]	367
CC (forward voltage driver) (V)	52.0
Inrush current time (µs)	100.0
Inrush current I _{max} (A)	5.0
Height (product) (mm)	90.0
Weight (product) (kg)	0.625
Diameter (product) (mm)	98.0



FDV DOCUMENTATION

Ceto Fixed 1100lm 15W 930 36° BK EPN Phasecut cutout 92mm

Art.no: 28930-2-36-2



Lighting Solutions

LIGHT DISTRIBUTION

