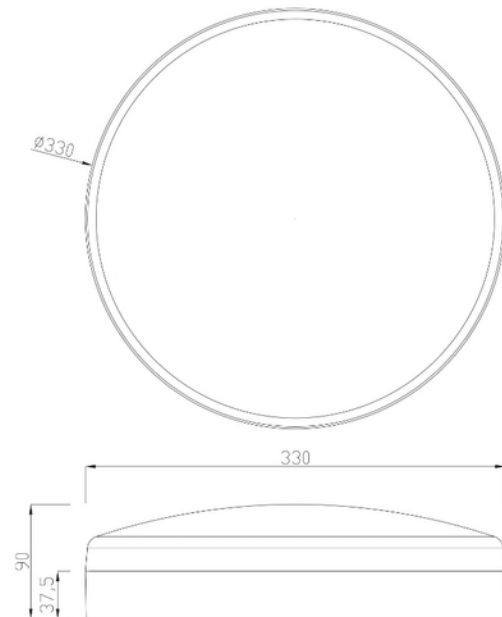

**FDV DOCUMENTATION**

Caph 2700lm 830/840/857 Switch 120° 24W WH Sensor

Art.no: 9035-S-120-3

*Lighting Solutions*

## Caph 2700lm 830/840/857 Switch 120° 24W WH Sensor



SPECIFICATIONS	
Inrush current time ( $\mu$ s)	27.6
Inrush current I <sub>max</sub> (A)	31.2
Width (product) (mm)	330.0
Height (product) (mm)	90.0
Weight (product) (kg)	0.84



**FDV DOCUMENTATION**

Caph 2700lm 830/840/857 Switch 120° 24W WH Sensor

Art.no: 9035-S-120-3



*Lighting Solutions*

**LIGHT DISTRIBUTION**

