



FDV DOCUMENTATION

Ceto Fixed 1100lm 15W 927 36° BK EPN0024 w/o driver
Art.no: 28927-2-01-36-2



Lighting Solutions



92mm

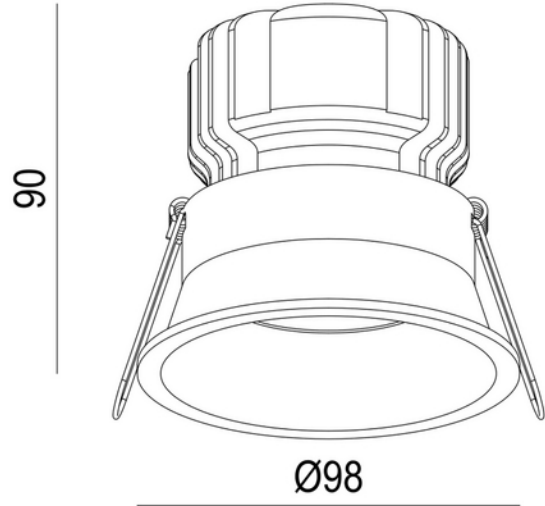

Ceto Fixed 1100lm 15W 927 36° BK EPN0024 w/o driver



SPECIFICATIONS	
Operating temperature (°C)	45
Forward Voltage LED (max tp=25) (V)	36.0
Forward Voltage LED (min tp=65) (V)	32.0
Height (product) (mm)	90.0
Weight (product) (kg)	0.441666666666667
Diameter (product) (mm)	98.0



FDV DOCUMENTATION

Ceto Fixed 1100lm 15W 927 36° BK EPN0024 w/o driver

Art.no: 28927-2-01-36-2



Lighting Solutions

LIGHT DISTRIBUTION

