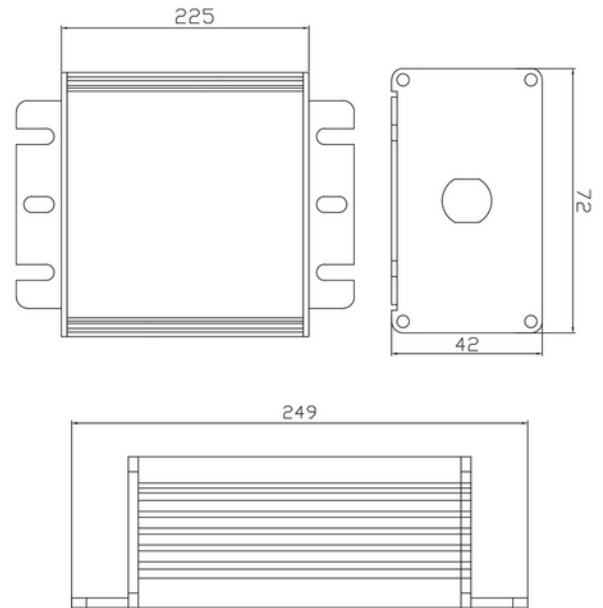

**FDV DOCUMENTATION**

Driver 24V cv 200W Phasecut IP67 AcTec

Art.no: V2-200-24T

*Lighting Solutions*

Driver 24V cv 200W Phasecut IP67 AcTec



SPECIFICATIONS	
Protection Class (driver)	2
Inrush current time (μ s)	900.0
Inrush current I _{max} (A)	40.0
Length (product) (mm)	249.0
Width (product) (mm)	72.0
Height (product) (mm)	40.0
Weight (product) (kg)	1.2